

# MOTORS AND CONTROLS

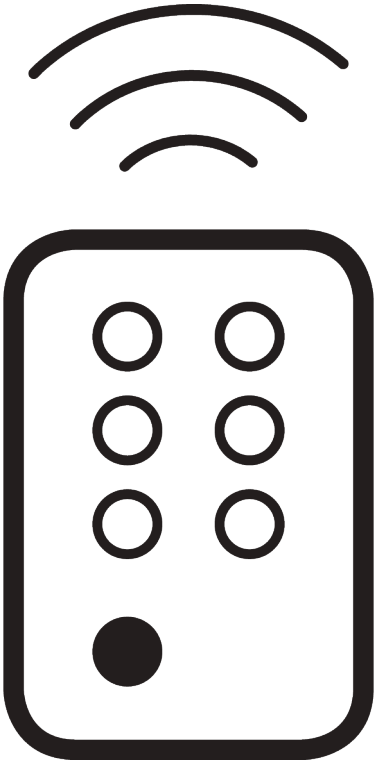

# GENERAL NOTES

- *Installation by qualified fitter only.*
- *All radio installations must be installed according to local regulations.*
- *Electrical installations must be carried out according to Silent Gliss wiring diagrams.*
- *Check space for cables and plugs!*

# APPLICATION CHART

<u>PAGE</u>	<u>SYSTEM</u>
5	<b>SG Control A</b>
11	<b>SG Control L</b>
19	<b>SG Control R</b>
25	<b>SG Smart</b>



# SG Control A

---

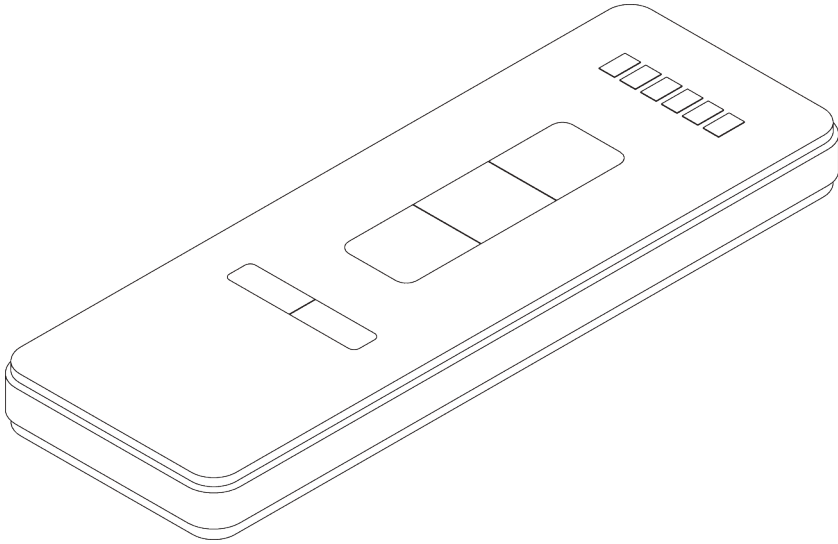

## PRODUCT INFORMATION

- *Radio controlled*
- *1-channel, 2-channel, 5-channel or 6-channel radio controls*
- *Radio hand held and wall controls*
- *Single and multi channel timer units*

# APPLICATION

## A. SYSTEMS

- Electric curtain track system SG 5100
- Roller blind system SG 4955
- Roman blind system SG 2345

# OVERVIEW COMPONENTS

## A. RADIO CONTROLS

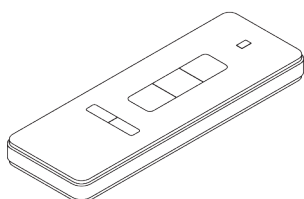

### **SG 10946**

- **Channel:** 1 channel
- **Frequency:** 433.92 MHz
- **Colours:** white

#### **Features:**

- Operates single system or operates one group of systems

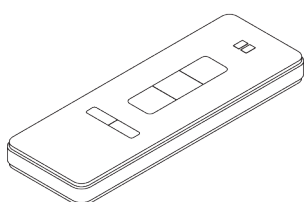

### **SG 10947**

- **Channel:** 2+1 channel
- **Frequency:** 433.92 MHz
- **Colours:** white

#### **Features:**

- 2 channel: operates up to two single systems individually
- 2 channel: operates up to two groups of systems individually
- 1 channel: operates all systems together

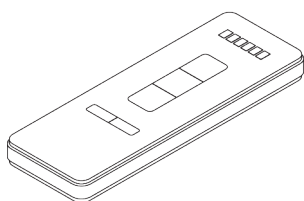

### **SG 10948**

- **Channel:** 6+1 channel
- **Frequency:** 433.92 MHz
- **Colours:** white

#### **Features:**

- 6 channel: operates up to 6 single systems individually
- 6 channel: operates up to 6 groups of systems individually
- 1 channel: operates all systems together

## B. RADIO WALL CONTROLS

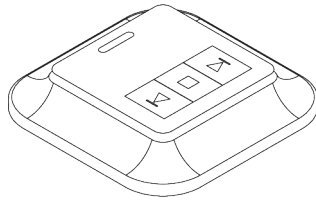

### **SG 10949**

- **Channel:** 1 channel
- **Frequency:** 433.92 MHz
- **Colours:** white

#### **Features:**

- Operates single system or operates one group of systems

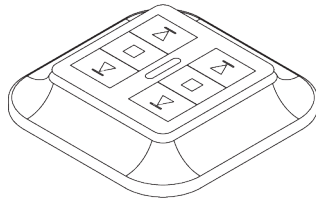

### **SG 10950**

- **Channel:** 2 channel
- **Frequency:** 433.92 MHz
- **Colours:** white

#### **Features:**

- 2 channel: operates up to two single systems individually
- 2 channel: operates up to two groups of systems individually

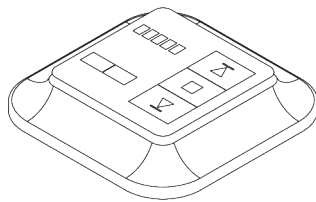

### **SG 10951**

- **Channel:** 5+1 channel
- **Frequency:** 433.92 MHz
- **Colours:** white

#### **Features:**

- 5 channel: operates up to 5 single systems individually
- 5 channel: operates up to 5 groups of systems individually
- 1 channel: operates all systems together

## C. RADIO TIMER UNITS

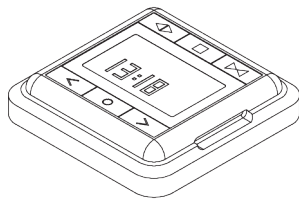

### **SG 11429**

- **Channel:** 1 channel
- **Frequency:** 433.92 MHz
- **Colours:** white

#### **Features:**

- Operates single system
- Operates one group of systems
- LCD display
- Touch button control
- Single 'open' and 'close' time setting

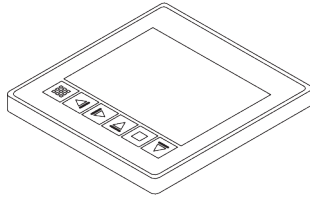

**SG 11093**

- **Channel:** 16 channel
- **Frequency:** 433.92 MHz
- **Colours:** white

**Features:**

- 16 channel: operates up to 16 single systems individually
- 16 channel: operates up to 16 groups of systems individually
- LCD display
- Touch button control
- Timing function with max. 8 timing points programmable for daily and weekly cycles

**D. MANUALS**

Refer to Silent Gliss website.

# COMBINATION CONTROLS AND SYSTEMS

**A. EXAMPLE**

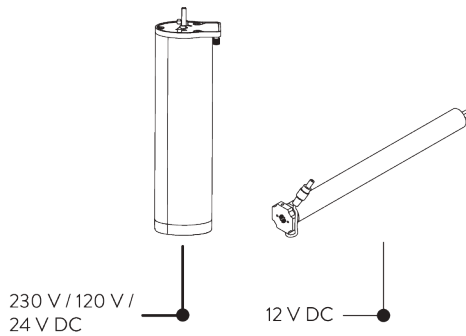

Applicable with following systems:

- Electric curtain track system SG 5100
- Roller blind system SG 4955
- Roman blind system SG 2345

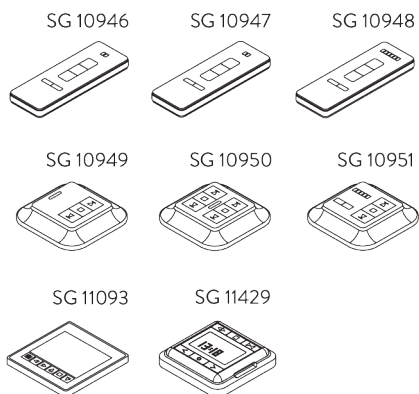

**B. WIRING  
DIAGRAMS**



Refer to Silent Gliss website.



# PARTS

## A. CONTROLS



**SG 10946**

*Radio hand held 1 channel*



**SG 10947**

*Radio hand held 2+1 channel*



**SG 10948**

*Radio hand held 6+1 channel*



**SG 10949**

*Radio wall transmitter 1 channel*



**SG 10950**

*Radio wall transmitter 2 channel*



**SG 10951**

*Radio wall transmitter 5+1 channel*



**SG 11429**

*Radio timer unit 1 channel*



# SG Control L

---

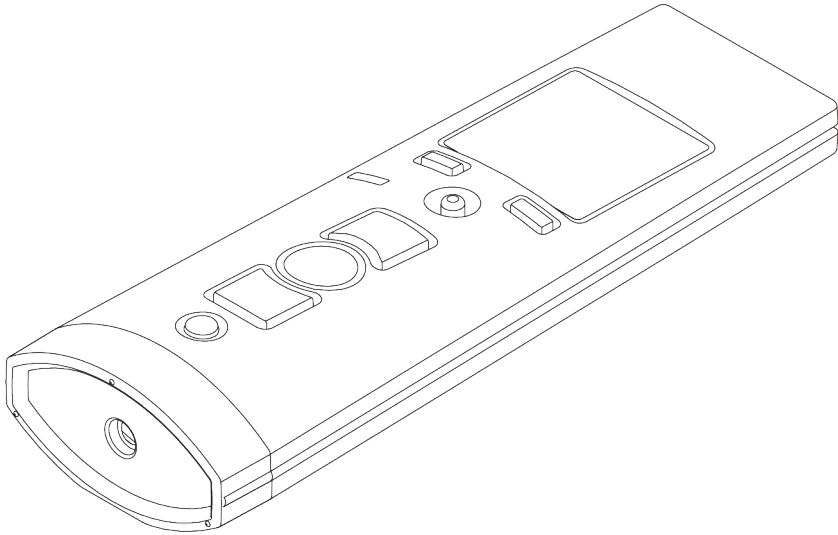

## PRODUCT INFORMATION

- *Radio controlled*
- *Bi directional*
- *1-channel, 5-channel, 10-channel or 15-channel radio controls*
- *Radio hand held and wall controls*
- *Radio receivers for motors without integrated receiver*
- *Silent Gliss Move App*

# APPLICATION

## A. SYSTEMS

- Dim-out blind system SG 4760
- Dim-out blind system SG 4770
- Dim-out blind system SG 4780
- Electric curtain track system SG 5600
- Electric curtain track system SG 5800
- Panel Glide System SG 2750
- Pleated blind system SG 8500
- Roller blind system SG 4960
- Roller blind system SG 4970
- Roller blind system SG 4880
- Roman blind system SG 2350
- Skylight shading system SG 2195
- Skylight shading system SG 8600
- Skylight shading system SG 8640
- Venetian blind system SG 8250
- Venetian blind system SG 8960
- Vertical blind system SG 2950

# OVERVIEW COMPONENTS

## A. RADIO CONTROLS

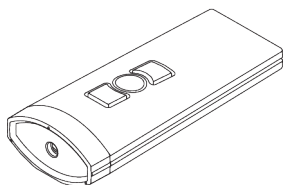

### **SG 10300**

- **Channel:** 1 channel
- **Frequency:** 868 or 915 MHz
- **Colours:** white, silver and anthracite

#### **Features:**

- Operates single system or operates one group of systems
- Wall holder in corresponding colour

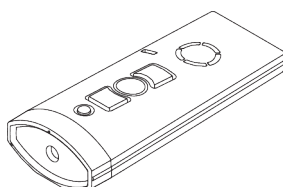

### **SG 10302**

- **Channel:** 5+1 channel
- **Frequency:** 868 or 915 MHz
- **Colours:** white, silver and anthracite

#### **Features:**

- 5 channel: operates up to 5 single systems individually
- 5 channel: operates up to 5 groups of systems individually
- 1 channel: operates all systems together
- Wall holder in corresponding colour

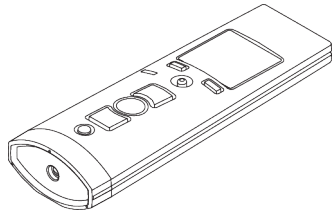

### SG 10303

- **Channel:** 10+2+1 channel
- **Frequency:** 868 or 915 MHz
- **Colours:** white, silver and anthracite

#### Features:

- 10 channel: operates up to 10 single systems individually
- 10 channel: operates up to 10 groups of systems individually
- 2 channel: combines the 10 groups into 2 groups and operates them individually
- 1 channel: operates all systems together
- Various languages
- Programmable day and week, sunrise and sunset time
- Holiday mode
- Illuminated display
- Astro times
- Wall holder in corresponding colour

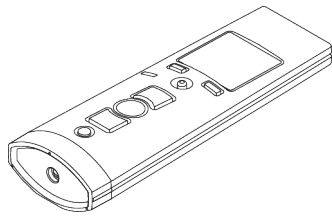

### SG 10804

- Channel: 15+5+1 channel
- Frequency: 868 or 915 Mhz
- Colours: white, silver and anthracite

#### Features:

- 15 channel: operates up to 15 single systems individually
- 15 channel: operates up to 15 groups of systems individually
- 5 channel: combines the 15 groups into 5 groups and operates them individually
- 1 channel: operates all systems together
- Various languages
- Intelligent display management
- Wall holder in corresponding colour

## B. RADIO WALL CONTROLS

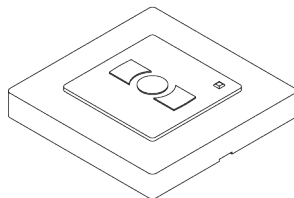

### SG 11480

- **Channel:** 1 channel
- **Frequency:** 868 or 915 MHz
- **Colours:** white

#### Features:

- Operates single system or operates one group of systems

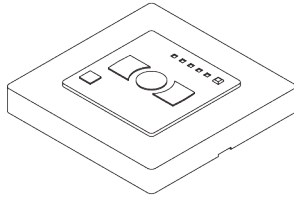

### SG 11490

- **Channel:** 5+1 channel
- **Frequency:** 868 or 915 MHz
- **Colours:** white

#### Features:

- 5 channel: operates up to 5 single systems individually
- 5 channel: operates up to 5 groups of systems individually
- 1 channel: operates all systems together

## C. MOVE BY SILENT GLISS

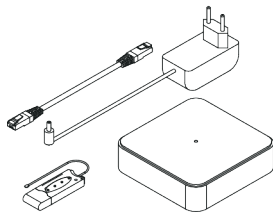

### SG 9960

- **Channel:** 15 channel
- **Frequency:** 868 or 915 MHz
- **Colours:** black
- **Move server set:** consists of server and transmitter stick SG 9961

#### Features:

- Operates up to 15 single systems individually (per stick)
- Operates up to 15 groups of systems individually (per stick)
- Slot for two transmitter sticks SG 9961
- App available for Android and IOS
- Various languages
- "Scenes" programmable
- Programmable day and week, sunrise and sunset time
- Holiday mode
- Astro times

## D. RADIO RECEIVERS

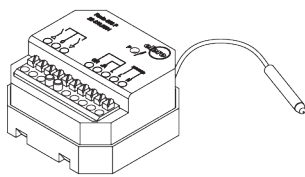

### SG 9068

- **Channel:** 1 channel
- **Frequency:** 868 or 915 MHz
- **Voltage:** 230 or 120 V

#### Features:

- Operates single system
- Flush mounting

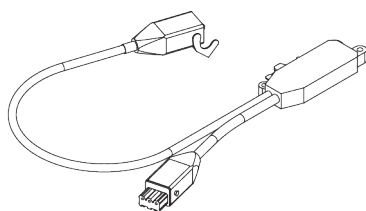

### SG 9944

- **Channel:** 1 channel
- **Frequency:** 868 or 915 MHz
- **Voltage:** 230 or 120 V

#### Features:

- Operates single system
- Non latching mode

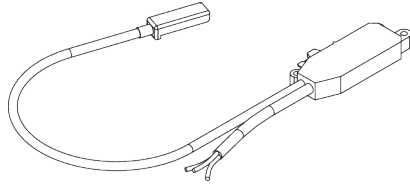
**SG 9945**

- **Channel:** 1 channel
- **Frequency:** 868 or 915 MHz
- **Voltage:** 230 or 120 V

**Features:**

- Operates single system
- Latching mode

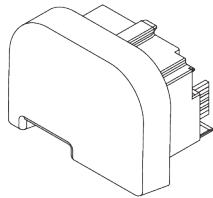
**SG 9063**

- **Channel:** 1 channel
- **Frequency:** 868 or 915 MHz

**Features:**

- Only applicable with motor SG 9060 (electric curtain track system SG 5600)

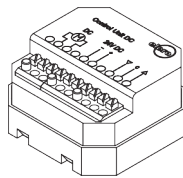
**E. CONTROL UNIT****DC****SG 9947**

- **Voltage:** 24 V DC

**Features:**

- Relay
- Flush mounting
- Needed with SG 8250 or SG 8500

**F. MANUALS**

Refer to Silent Gliss website.

# COMBINATION CONTROLS / RECEIVERS AND SYSTEMS

## A. EXAMPLES

### Motors with integrated receiver

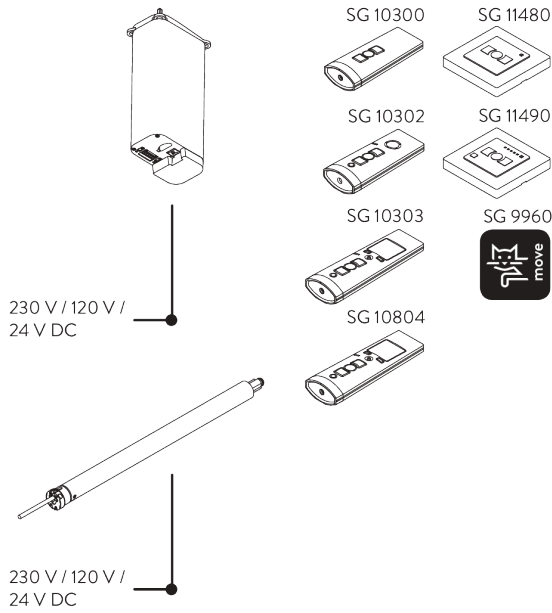

Applicable with following systems:

- Dim-out blind system SG 4760
- Dim-out blind system SG 4770
- Dim-out blind system SG 4780
- Electric curtain track system SG 5600
- Panel glide system SG 2750
- Roller blind system SG 4960
- Roller blind system SG 4970
- Roller blind system SG 4880
- Roman blind system SG 2350
- Vertical blind system SG 2950
- Venetian blind system SG 8960 (230 V)

### Motors without integrated receiver

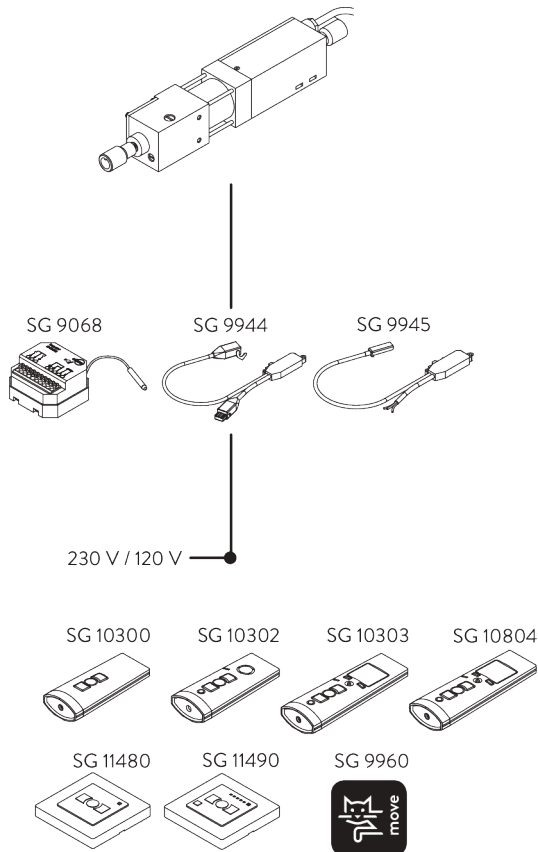

Applicable with following systems:

- Electric curtain track system SG 5800
- Skylight shading system SG 2195
- Skylight shading system SG 8600
- Skylight shading system SG 8640



**24 V DC motors  
without integrated  
receiver**

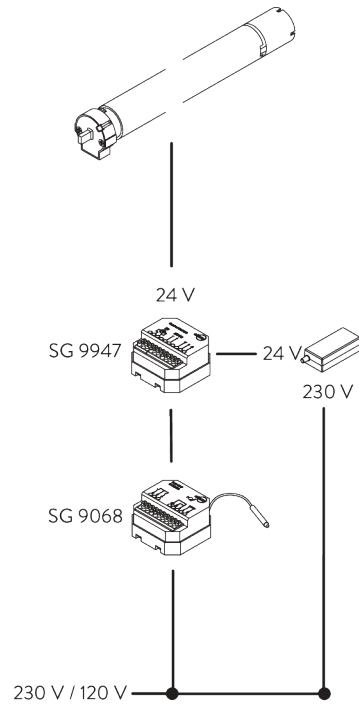

Applicable with following systems:

- Roller blind system SG 4960
- Pleated blind system SG 8500
- Venetian blind system SG 8250

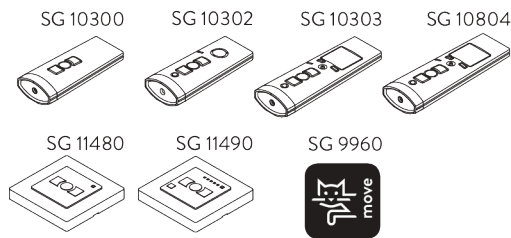

**B. WIRING**  
**DIAGRAMS**



Refer to Silent Gliss website.

# PARTS

## A. CONTROLS / RECEIVERS

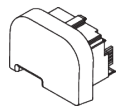

**SG 9063**

Radio module type L

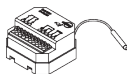

**SG 9068**

Radio receiver Revio

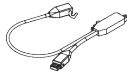

**SG 9944**

Radio receiver 1 channel

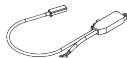

**SG 9945**

Radio receiver 1 channel

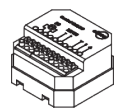

**SG 9947**

Control unit DC 24V



**SG 10300**

Radio hand held 1 channel



**SG 10302**

Radio hand held 5+1 channel

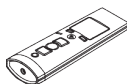

**SG 10303**

Radio hand held 10+2+1 channel



**SG 10804**

Radio hand held 15+5+1 channel



**SG 11480**

Radio wall transmitter 1 channel



**SG 11490**

Radio wall transmitter 5+1 channel

# SG Control R

---

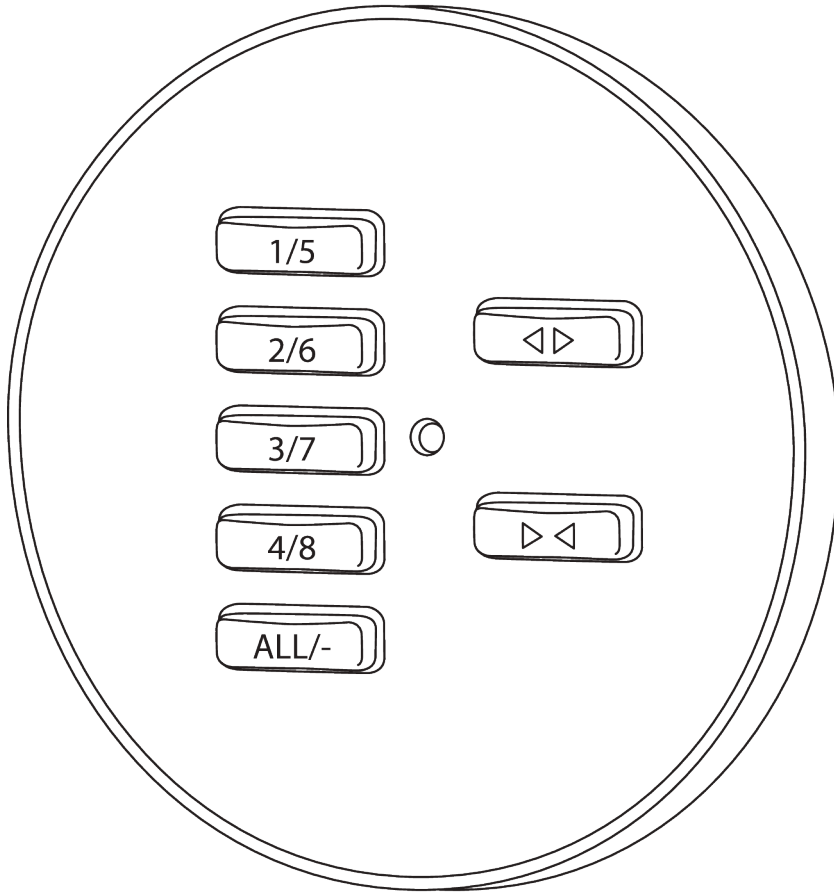

## PRODUCT INFORMATION

- Radio controlled
- Single-channel and 8-channel radio controls
- Radio hand-held and wall mounted controls
- Radio receivers for motors without integrated receiver
- Wall switch finishes – mirror polish steel, stainless steel, brass

# APPLICATION

## A. SYSTEMS

- Dim-out blind system SG 4760
- Dim-out blind system SG 4770
- Dim-out blind system SG 4780
- Electric curtain track system SG 5600
- Electric curtain track system SG 5800
- Pleated blind system SG 8500
- Roller blinds system SG 4960
- Roller blinds system SG 4970
- Roller blinds system SG 4880
- Roman blind system SG 2350
- Skylight shading system SG 2195
- Skylight shading system SG 8640
- Skylight shading system SG 8600
- Venetian blind system SG 8250
- Venetian blind system SG 8960
- Vertical blind system SG 2950

# OVERVIEW COMPONENTS

## A. RADIO WALL CONTROLS

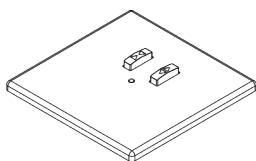

### **SG 20913**

- **Channel:** 1 channel
- **Frequency:** 433.9 MHz
- **Colours:** Mirror polish steel, brushed stainless steel, brass

#### **Features:**

- Operates single system or one group of systems
- Requires installation into an existing recessed back box (min. depth 16 mm)

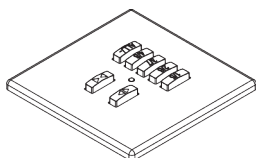

### **SG 20914**

- **Channel:** 8 channel
- **Frequency:** 433.9 MHz
- **Colours:** Mirror polish, brushed stainless, brass

#### **Features:**

- 8 channel: operates up to 8 systems individually
- 8 channel: operates up to 8 groups of systems individually
- 1 channel operates all systems together
- Requires installation into an existing recessed back box (min. depth 16 mm)

## B. RADIO CONTROLS

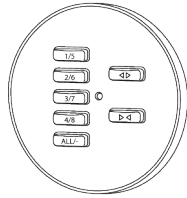

### **SG 20336**

- **Channel:** 8 channel
- **Frequency:** 433.9 MHz
- **Colours:** Mirror polish steel, Brushed stainless steel, brass

#### **Features:**

- 8 channel: operates up to 8 systems individually
- 8 channel: operates up to 8 groups of systems individually
- 1 channel operates all systems together

## C. RADIO RECEIVERS

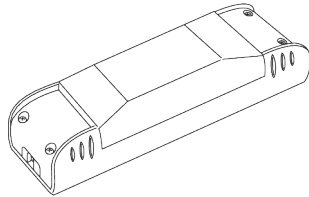

### **SG 20907**

- **Channel:** 1 channel
- **Frequency:** 433.9 MHz
- **Voltage Input:** 24 V
- **Volt output :** 24 V

#### **Features:**

- Operates 24V single system
- For motors without integrated receiver

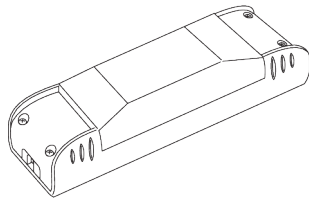

### **SG 20919**

- **Channel:** 1 channel
- **Frequency:** 433.9 MHz
- **Voltage input:** 230 V
- **Voltage output:** 230V

#### **Features:**

- Operates 230 V single system
- For motors without integrated receiver

## D. MANUALS

Refer to Silent Gliss website.

# COMBINATION CONTROLS / RECEIVERS AND SYSTEMS

## A. EXAMPLES

### Motors with integrated receiver

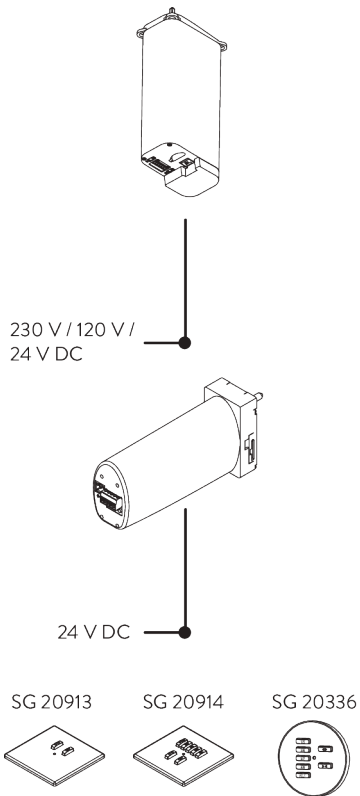

Applicable with the following systems:

- Electric curtain track system SG 5600
- Vertical blind system SG 2950

### Motors without integrated receiver

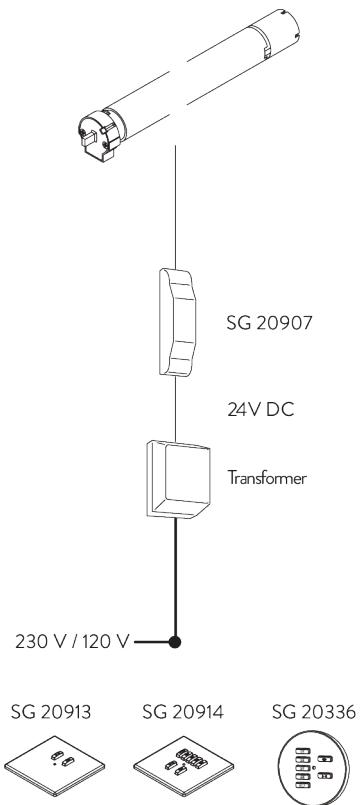

Applicable with the following systems:

- Pleated blind system SG 8500
- Venetian blind system SG 8250

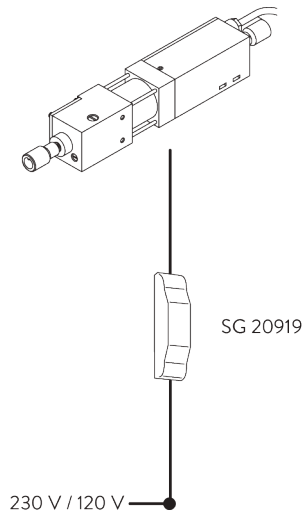

Applicable with the following systems:

- Dim-out blind system SG 4760
- Dim-out blind system SG 4770
- Dim-out blind system SG 4780
- Electric curtain track system SG 5800
- Roller blinds system SG 4960
- Roller blinds system SG 4970
- Roller blinds system SG 4880
- Roman blind system SG 2350
- Skylight shading system SG 2195
- Skylight shading system SG 8640
- Skylight shading system SG 8600

**B. WIRING  
DIAGRAMS**



Refer to Silent Gliss website.

# PARTS

## A. CONTROLS / RECEIVERS

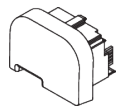

**SG 11411**

Radio module type R



**SG 20336**

Hand held transmitter 8 channel

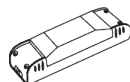

**SG 20907**

Control module motor type R



**SG 20913**

Wall switch single channel



**SG 20914**

Wall switch 8 channel

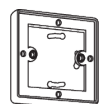

**SG 20917**

Pattness box

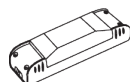

**SG 20919**

Control module motor type R



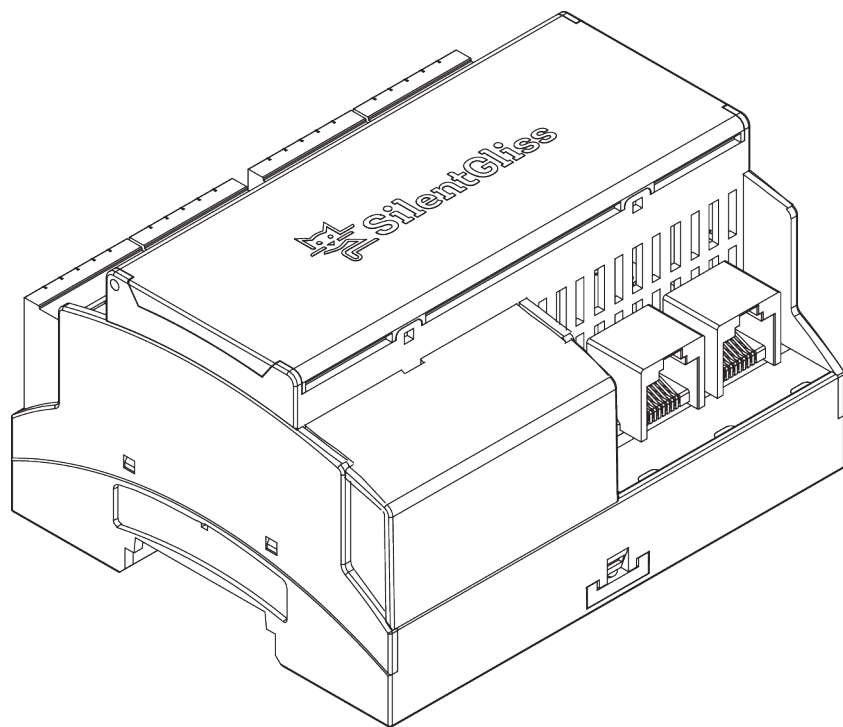

## **PRODUCT INFORMATION**

- *Two way communication between motors and control system*
- *Works in conjunction with specific third party control systems*
- *Precise motor control*
- *Wide range of Silent Gliss product types*

# APPLICATION

## A. SYSTEMS

- Dim-out blind system SG 4760
- Dim-out blind system SG 4770
- Dim-out blind system SG 4780
- Electric curtain track system SG 5600
- Roller blind system SG 4960
- Roller blind system SG 4970
- Roller blind system SG 4880
- Roman blind system SG 2350
- 
- Panel glide system SG 2750

# OVERVIEW COMPONENTS

## A. SMART COMPONENTS

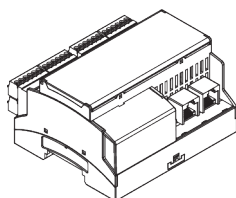

### **SG 11260 Gateway Cedia**

- Din rail mounted

#### **Features:**

- Controls up to 8 motors
- Up to 64 motors when combined with Expansion Units SG 11262
- Key communication link with primary control system
- Plug in connector blocks

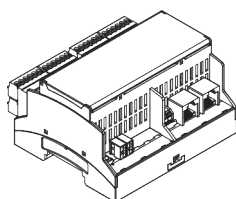

### **SG 11261 Gateway KNX**

- Din rail mounted

#### **Features:**

- For use with KNX based control systems
- Key communication link with primary control systems
- Controls up to 8 motors
- Up to 64 motors when combined with expansion units SG 11262
- Plug in connector blocks

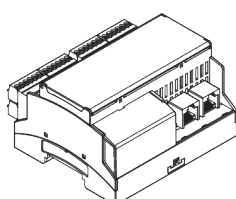

### **SG 11262 Expansion Unit**

- Din Rail mounted
- Used in conjunction with Gateways

#### **Features:**

- Controls up to 8 motors
- Plug in connector blocks

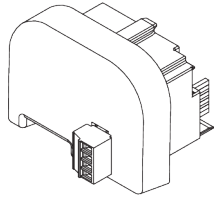

### **SG 11270 Smart Module**

- Smart Module for SG 5600 system
- Works exclusively with Smart Gateway components

#### **Features:**

- Simple "plug in" module for SG 9060 motors
- Screw connector blocks

## **B. POWER SUPPLIES**

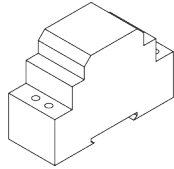

### **SG 11263 Power Supply**

- 24 V DC 2.5 A output
- Din rail mounted

#### **Features:**

- Powers Gateway components SG 11260 / SG 11261
- Variable input voltage
- Output range 21.6 - 29 V DC

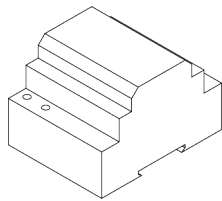

### **SG 11264 Power Supply**

- 24 V DC 3.8 A output
- Din Rail mounted

#### **Features:**

- Variable input voltage
- Output range 21.6 - 29 V DC

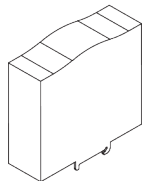

### **SG 11265 Power Supply**

- 24 V DC 5 A output
- Din rail mounted

#### **Features:**

- Variable input voltage
- Output range 24 - 28 V DC

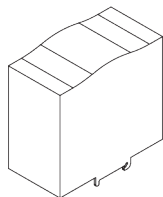

### **SG 11266 Power Supply**

- 24 V DC 10 A output
- Din rail mounted

#### **Features:**

- Variable input voltage
- Output range 24 - 28 V DC

## C. CABINETS

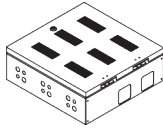

### **SG 11281 Cabinet**

- 8 system cabinet

#### **Features:**

- Takes up to 8 smart product systems
- Steel construction
- Wall mounted
- Size 520 mm W x 510 mm L x 196.5 mm D
- Complete with 100 A mains power breaker

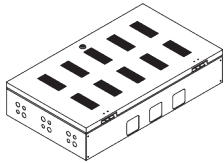

### **SG 11282 Cabinet**

- 24 system cabinet

#### **Features:**

- Takes up to 24 smart product systems
- Steel construction
- Size 520 mm W x 890 mm L x 196.5 mm D
- Complete with 100 A mains power breaker

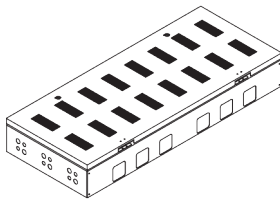

### **SG 11283 Cabinet**

- 56 system cabinet

#### **Features:**

- Takes up to 56 smart product systems
- Steel construction
- Size 520 mm W x 1250 mm L x 196.5 mm D
- Complete with 100 A mains power breaker

## D. MANUALS

Refer to Silent Gliss website.

# COMBINATION CONTROLS AND SYSTEMS

## A. EXAMPLE

### Schematic Smart system arrangement

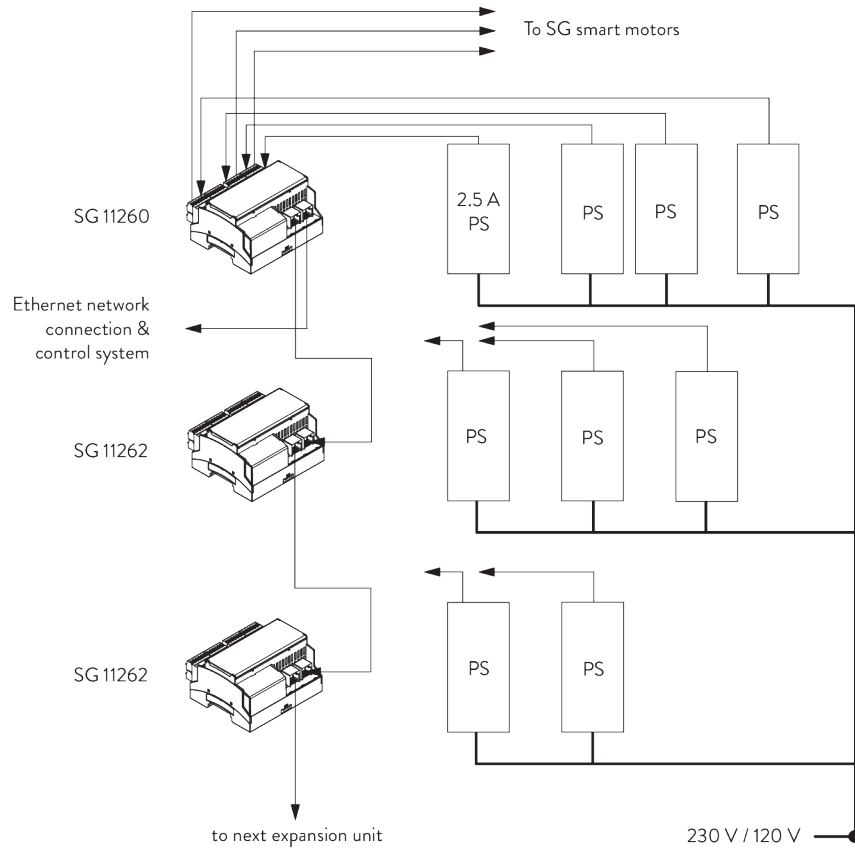

## B. WIRING DIAGRAMS



Refer to Silent Gliss website.

# PARTS

## A. CONTROLS

**SG 11250**

Motor 24V DC, 50-Series 1.5/55

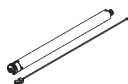
**SG 11251**

Motor 24V DC, 50-Series 3/32

**SG 11252**

Motor 24V DC, 50-Series 6/20

**SG 11255**

Motor 24V DC, 50-Series 10/20

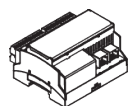
**SG 11260**

Gateway Cedia

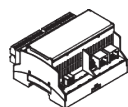
**SG 11261**

Gateway KNX

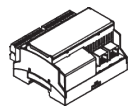
**SG 11262**

Expansion unit

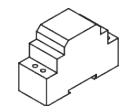
**SG 11263**

Power supply 24V DC, 2.5A DIN Rail

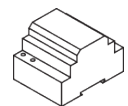
**SG 11264**

Power supply 24V DC, 3.8A DIN Rail

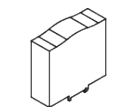
**SG 11265**

Power supply 24V DC, 5A DIN Rail

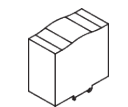
**SG 11266**

Power supply 24V DC, 10A DIN Rail

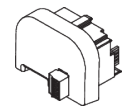
**SG 11270**

Smart module

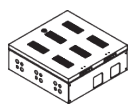
**SG 11281**

Cabinet for 8 systems

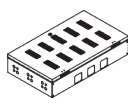
**SG 11282**

Cabinet for 24 systems

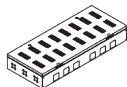
**SG 11283**

Cabinet for 56 systems

**SG 11325**

Smart plug 6-pin, MC 1.5/6 ST-3.81



## ***The Architects of Silence***

***Silent Gliss is the leading global supplier of premium interior window treatments. Since 1952 we have been tirelessly committed to the development of the world's smoothest, quietest systems using state of the art technology.***

*Driven by customer needs, Silent Gliss offers functional and durable products. Expert technical advice coupled with installation and support services complete the offer. Silent Gliss stands for innovative, sustainable, tailor made solutions, exceptional design and first-class quality.*

### **Silent Gliss Ltd.**

Pyramid Business Park  
Poorhole Lane, Broadstairs  
Kent CT10 2PT  
United Kingdom  
**T** +44 1843 863571  
**F** +44 1843 864503  
info@silentgliss.co.uk

### **Silent Gliss Global Ltd.**

Pyramid Business Park  
Poorhole Lane, Broadstairs  
Kent CT10 2PT  
United Kingdom  
**T** +44 1843 874250  
**F** +44 1843 864503  
info@silentglissglobal.com

### **Silent Gliss Blinds Trading LLC**

Office 1906  
The H Hotel Complex  
Trade Center First  
Dubai  
United Arab Emirates  
**T** +971 4 7050318  
info@silentgliss.ae

**silentgliss.co.uk**  
**silentglissglobal.com**  
**silentgliss.ae**